



R38

MICROPROCESSOR BASED DIGITAL ELECTRONIC CONTROLLER



Instruction manual

Vr. 1.3 (ENG) - code.: ISTR- FR38ENG13

ASCON TECNOLOGIC S.r.l.

VIA INDIPENDENZA 56
27029 VIGEVANO (PV) ITALY
Tel.: +39 0381 69871 - FAX: +39 0381 698730
http://www.ascontecnologic.com
e-mail: info@ascontecnologic.com

1. OUTLINE DIMENSIONS (mm)

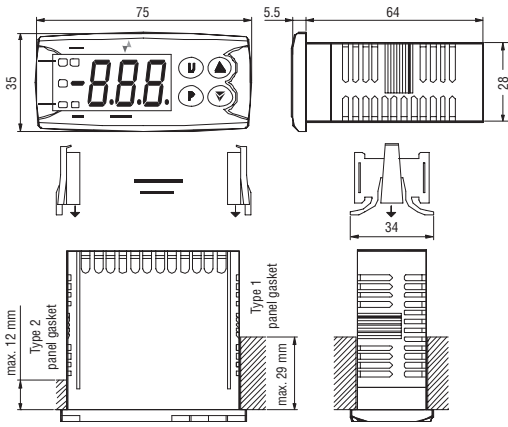

2. CONNECTION DIAGRAM

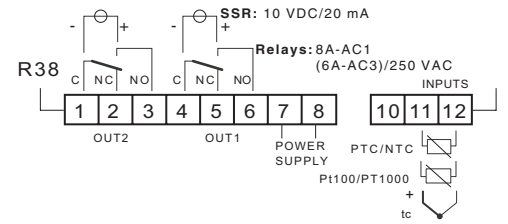

2.1 - MOUNTING REQUIREMENTS

This instrument is intended for permanent installation, for indoor use only, in an electrical panel which encloses the rear housing, exposed terminals and wiring on the back.

Select a mounting location having the following characteristics:

- 1) It should be easily accessible;
- 2) There is minimum vibrations and no impact;
- 3) There are no corrosive gases;
- 4) There are no water or other fluid (i.e. condensation);
- 5) The ambient temperature is in accordance with the operative temperature (0 to 50 °C);
- 6) The relative humidity is in accordance with the instrument specifications (20% to 85 %).

The instrument can be mounted on panel with a maximum thickness of 15 mm. When the maximum front protection (IP65) is desired, the optional gasket must be mounted.

2.2 - GENERAL NOTES ABOUT INPUT WIRING

- 1) Do not run input wires together with power cables;
- 2) External components (like zener barriers, etc.) connected between sensor and input terminals may cause errors in measurement due to excessive and/or not balanced line resistance or possible leakage currents;
- 3) When a shielded cable is used, it should be connected at one point only;
- 4) Pay attention to the line resistance; a high line resistance may cause measurement errors.

2.3 - THERMOCOUPLE INPUT

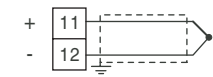

Fig. 3 - Thermocouple input wiring

External resistance: 100Ω max., max. error 0.5% of span.

Cold junction: automatic compensation from 0 to 50°C.

Cold junction accuracy: 0.1 °C/°C after a warm-up of 20 minutes.

Input impedance: > 1 MΩ.

Calibration: according to EN 60584-1.

Note: For TC wiring use proper compensating cable preferable shielded.

2.4 - PT100 INPUT

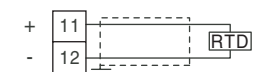

Fig. 4 - PT100 input wiring

Input circuit: current injection (135 μA).

Line resistance: not compensated.

Calibration: according to EN 60751/A2.

2.5 - PTC/NTC/PT1000 INPUT

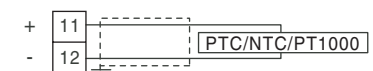

Fig. 5 - PTC/NTC/PT1000 input wiring

Input circuit: current injection (25μA).

Line resistance: not compensated.

2.6 - OUTPUTS

Safety notes:

- 1) To avoid electrical shock, connect supply cables last.
- 2) For supply connections use 16 AWG or larger wires rated for at least 75°C.
- 3) Use copper conductors only.
- 4) SSR (Solid State Relay) Outputs are NOT isolated. A double or reinforced isolation between instrument output and power supply must be assured by the external solid state relay.

a) Output 1 Relay

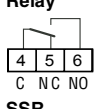

Contact rating: 8 A /250 V cosφ=1
3 A /250 V cosφ=0.4
Operations: 1 x 10⁵

Logic level 0: Vout < 0.5 Vdc
Logic level 1: 12 V ±20% @ 1 mA
10 V ±20% @ 20 mA.

b) Output 2 Relay

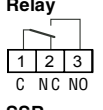

Contact rating: 8 A /250 V cosφ=1
3 A /250 V cosφ=0.4
Operations: 1 x 10⁵

Logic level 0: Vout < 0.5 Vdc
Logic level 1: 12 V ±20% @ 1 mA
10 V ±20% @ 20 mA.

2.7 - POWER SUPPLY

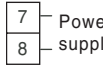

Power consumption: 5VA max.
Supply voltage: 100 V to 240 VAC/DC (+10%)
12 VDC (-15% to +10%)
24 VAC/DC (-15% to +10%)

Notes:

- 1) Before connecting the instrument to the electrical supply, make sure that line voltage is equal to the voltage shown on the identification label.
- 2) To avoid electrical shock, connect supply cables at the end of the wiring procedure.
- 3) For supply connections use 16 AWG or larger wires rated for at least 75°C.
- 4) Use copper conductors only.
- 5) Do not place signal cables parallelly or next to power cables or to noise sources.
- 6) The power supply input is NOT fuse protected. Please, provide a T type 1A, 250 V fuse externally.
- 7) For DC power supply the polarity is a do not care condition.

3. TECHNICAL CHARACTERISTICS

3.1 - TECHNICAL SPECIFICATIONS

Case: Plastic, self-extinguishing degree: V-0 according to UL 94.

Front protection: IP 65 (when the optional panel gasket is mounted) for indoor locations according to EN 60070-1.

Rear terminals protection: IP 20 according to EN 60070-1.

Installation: Panel mounting.

Terminal block: 11 screw terminals (screw M3, for cables from 0.25 to 2.5 mm² or from 22 AWG to 14 AWG).

Dimensions: 75 x 33 mm, depth 75.5 mm.

Cutout: 71 (-0 to +0.5 mm) x 29 (-0 to +0.5 mm).

Weight: 180 g approximately.

Insulation voltage: 2300 V rms according to EN 61010-1.

Display: one 3 digits red display h 12 mm.

Display updating time: 500 ms.

Sampling time: 130 ms.

Resolution: 20000 counts.

Total Accuracy: +0.5% E.S.V. +1 digit @ 25°C of room temp..

Electromagnetic compatibility and safety requirements:
Compliance: directive EMC 2004/108/CE (EN 61326-1),
directive LV 2006/95/CE (EN 61010-1).

Installation category: II.

Pollution category: 2.

Temperature drift: It is part of the global accuracy.

Operating temperature: 0 to 50°C (32 to 122°F).

Storage temperature: -30 to +70°C (-22 to 158°F).

Humidity: 20% to 85% RH, non condensing.

3.2 - HOW TO ORDER

Model

R38 - = Controller

R38S = Controller with S-touch keyboard (capacitive keyboard)

Power supply

F = 12 VAC/DC not isolated

L = 24 VAC/DC

H = 100... 240 VAC/DC

Input

F = TC J or K

A = PT100

T = PTC, NTC or PT1000.

Output Out 1

R = SPDT 8A-AC1 relay

O = VDC for SSR

Output Out 2

- = Not available

R = SPDT 8A-AC1 relay

O = VDC for SSR

4. CONFIGURATION PROCEDURE

4.1 - INTRODUCTION

When the instrument is powered, it initially works according to the parameter values loaded in its memory.

The instruments behavior and its performance are governed by the value of the memorized parameters.

At the first start up the instrument will use a "default" parameter set (factory parameter set); this set is a generic one (e.g. a TC J input is programmed).

We recommend that you modify the parameters to suit your application (e.g. set the right input type, Control strategy and define an alarm, etc.).

To change these parameters you will need to enter the "Configuration procedure".

4.2 - INSTRUMENT BEHAVIOUR AT POWER UP

At power up the instrument can start in one of the following modes depending on its configuration:

Auto mode

- The display will show the measured value;
- The instrument is performing the standard loop control.

Stand by mode (St.bY)

- The display will show alternately the measured value and the message <<St.bY>> or <<od>>;
- The instrument does not perform any control (the control outputs are OFF);
- The instrument is working as an indicator.

We define the above conditions as "Standard Display".

4.3 - FRONT PANEL DESCRIPTION

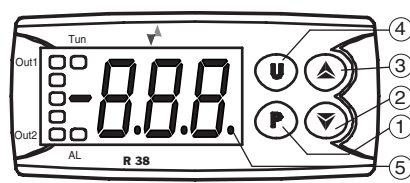

1 - Key P

- Pressed for 5 s, it allows access to the parameters programming mode.
- In the programming mode, it is used for the change of the parameters and for the confirmation of the values.
- Still in the programming mode, it can be used together with the ▲ key to modify the level of access (operator level or configuration level) of the selected parameter.
- During the normal functioning (not in programming phase), pressed together with the ▲ key for 5 s, it allows to lock and unlock the keyboard.
- During the normal functioning (not in programming phase), pressed together with the ◁ key for 5 s, it allows the reset or the acknowledgement of the alarms.

2 - Key ▽

- In the programming mode, it is used for to decrease the values to be programmed and for the selection of the parameters.
- During the normal functioning (not in programming phase), quickly pressed, it allows to visualize and to modify the value of the set point.

3 - Key ▲

- In the programming mode, it is used to increase the values to be programmed and for the selection of the parameters.
- Kept pressed for 3 s in the programming mode it can be used to exit from it and come back to the normal functioning.
- Still in the programming mode, it can be used together with the P key, to modify the level of access (operator level or configuration level) of the selected parameter.

- Pressed together with the ◁ key for 5 s, it unlocks the keyboard, when previously locked.

- During the normal functioning (not in programming phase), quickly pressed, it allows to visualize the output power.

4 - Key U

- If programmed through par. "ub.F", pressed for 1 s in the normal functioning mode, it allows the switch on/off (Stand-by) or to perform one of the possible functions (to start a cycle of Autotuning, etc.).

- During the normal functioning (not in programming phase), pressed together with the ◁ key for 5 s, it allows the reset or the acknowledgement of the alarms.

5 - LED Set

- In the programming mode, it is used for indicating the level of programming of parameters.

- If ub.F = Sb.o, when the instrument is in Stand-by mode, it remains the only lit LED.

- In the normal functioning mode, it flashes when a key is pressed to indicates the pressure has happend on the key.

6 - LED Out1

- It indicates the Out 1 condition (compressor or temperature control device) activated (on), deactivated (off) or inhibited (flashing).

7 - LED Out2

- It indicates the Out 2 condition.

8 - LED Tun

- It indicates the Autotuning is in progress.

4.4 - HOW TO ENTER THE CONFIGURATION PARAMETERS

Press P key and keep it pressed.

Condition 1: the instrument will show "Ln" (lock ON).

The keyboard is locked.

Maintaining the pressure on the ◁ key, also press the ▲ key. The LED Set begins to flash.

Keep the pressure on the two

Keep the pressure on the two keys until the display shows "LF" (lock OFF).

Now release the keys. The keyboard is now unlocked.

Note: If no button is pressed for a time longer than the time programmed with the Lo parameter, the key lock will be automatically enabled.

Condition 2: The instrument displays no message.

In this situation we can have 2 different cases:

Case 1: The parameters protection (password) is not active.

Press ◁ key and keep it pressed for around 5 seconds.

The display will show the code of the first configuration parameter.

With the ▽ and ▲ keys, select the parameter to be edited.

Case 2: The parameters protection (password) is active.

Press P key and keep it pressed for more than 5 seconds.

The display will show the code that identifies the first parameter that has been moved into the Operator level.

Press ▲ key. The display will visualize "r.P".

Press P key again. The display will show "0".

With the ▽ and ▲ keys, program the password and confirm it pushing P key again.

Note: the factory default password is 0 (no password).

2.A) If the password is correct, the instrument will show the code that identifies the first configuration parameter.

2.B) If the password is not correct, the instrument will show "r.P" again.

a) Once entered into the configuration parameters, select the parameter to be modified using the ▽ and ▲ keys.

b) Press ◁ key. The instrument will alternatively visualize the parameter's code and its value.

c) Modify the value of the parameter using the ▽ and ▲ keys.

d) Press ◁ key to memorize the new value. The display will return to visualize only the code of the selected parameter.

e) Working on ▽ and ▲ keys, it is therefore possible to select another parameter and to modify it as described on points a, b, c, d.

Note: The instrument will only show the parameters applicable to its hardware options in accordance with the specific instrument configuration (i.e. setting AL1t [Alarm 1 type] equal to <<nonE>> [not used], all parameters related with the alarm 1 will be skipped).

To go out from the programming mode do not work on any key for around 30 s, or press ▲ key for around 5 s.

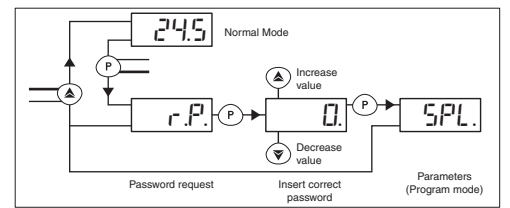

4.5 - PARAMETERS PROTECTION THROUGH A PASSWORD

The instrument has a function that protects the parameters through a password, programmable through parameter "PP." If you wish to have this protection, you have to set parameter "PP" to the number you'd like to be your password and then exit from parameters programming.

When the protection is active, to be able to have access to the parameters, press ◁ key and keep it pressed for around 5 s. Afterwards, the display will visualize "r.P", push the ◁ key again and the display will visualize "0."

Now, through the ▽ and ▲ keys, set the number of your password and press P key.

If the password is correct the display will visualize the code that identifies the first parameter and it will be possible to program it with the same procedure as described on the previous paragraph. The protection through password is disabled setting par. "PP" = 0F.

Note: If the password is forgotten, use password -18. This will allow you access to the protected parameters and it will be possible therefore to verify and also modify the parameter "PP."

4.6 - CUSTOMIZED PARAMETERS PROGRAMMING (levels of parameters programming)

The factory programming makes hides all the parameters behind the password with exception of the set point 1.

If you wish to modify some parameters, maintaining the protection on the others, after setting the Password through parameter "PP", it is necessary to follow this procedure:

a) Enter the programming through the Password.

b) Select the parameter to be programmable without password.

c.1) The LED Set is flashing.

- the parameter is protected by the password.

c.2) The LED Set is lit but not flashing.

- The parameter is not protected by the password.

To modify the level of access of the parameter (in other words: to have the parameter protected or not by the password) press the ◁ key and keeping it pressed press the ▲ key.

The LED Set will change its state, pointing out the new level of accessibility of the parameter (switched on = not protected; flashing = protected by password).

If the Password is enabled and some parameters have been set as "not protected", when entering the programming the instrument will first display all the parameters set as "not protected" and then, "r.P" parameter. By entering the password here all other parameters can be viewed.

4.7 - FACTORY RESET (default parameters loading procedure)

It is possible to restore the instruments factory configuration. To load the factory default parameter settings, proceed as follows:

- Enter in configuration mode (see 4.4 paragraph).

- If no password is programmed, set PP different from OFF.

- Exit from configuration procedure.

- Press the P button for more than 7 seconds. The display will show "rP".

- Release the P button and push it again. The display will show "0".

- By means of keys ▽ and ▲ set the value -48.

Once the password has been confirmed by pressing the ◁ key, the display shows for approximately 2 s "----", the instruments then runs through the start up procedure resetting all the parameters to the factory defaults.

4.8 - ON/STAND-BY FUNCTION

When supplied, the instrument can assume 2 different conditions:

- **ON**: means that the regulator activates the programmed control functions.

- **STAND-BY**: means that the regulator does not activate any control function and the control outputs are forced to zero (the display results switched on or off according to the programming done on parameter ub.F).

The instrument starts in the same way it was before the switch off. The condition of ON/STAND-BY can be selected through the U key when pressed for 1 s.

The passage from the STAND-BY to the ON condition, does not activate the Soft-start (or od) or the Autotuning and hides the alarms.

When the instrument is in STAND-BY mode with the display on the display alternates between the measure value and "St.b."

When the instrument is in STAND-BY with display off, the display is completely switched off except for the decimal point of the LSD (LED Set (5)).

When the instrument is in STAND-BY mode (both the visualizations) it is however possible to enter the parameters programming.

4.9 - ALL CONFIGURATION PARAMETERS

In the following pages we will describe all the parameters of the instrument. However, the instrument will only show the parameters applicable to its hardware options in accordance with the specific instrument configuration (i.e. setting o2F [Alarm] equal to <<nono>> [not used], all parameters related with the alarm will be skipped).

[1] SPL: Minimum Set Point value

Range: from -99.9 to SPH engineering units.

[2] SPH: Maximum Set Point value

Range: from SPL to 999 engineering units.

[3] SP1: Set Point

Range: from SPL to SPH engineering units.

[6] tun = Autotuning

Available: when o1.F = PID

ALL = the Autotuning is performed at every start up and parameters Pb, Ti and Td are hidden.

onE = the Autotuning is performed only at the next start up.

ub = Manual start up through  key (parameters Pb, Ti and Td are visible).

Note: When the Autotuning and the soft start, or the delay at the start up, have been programmed, the instrument performs first the soft start (with the parameters it has in memory) and then performs the Autotuning.

[7] Pb = Proportional band

Available: when o1F=PID and tun = ub.

Range: from 1 to 999 engineering units.

[8] ti = Integral time

Available: when o1F=PID and tun = ub.

Range: from 1 to 500 seconds and OFF (excluded).

[9] td = Derivative time

Available: when o1F=PID and tun = ub.

Range: from 0 (= OFF) to 200 seconds.

[10] SEn = Input type

Model	Selection	Sensor	Measuring range
F	J.C	TC J	-40 to 999 °C
	Ca.C	TC K	-40 to 999 °C
	J.F	TC J	-40 to 999 °F
	Ca.F	TC K	-40 to 999 °F
A	Pt.C	PT 100	-50.0 to 850 °C (autoranging)
	Pt.F	PT 100	-58.0 to 999 °F (autoranging)
T	nC.C	NTC	-50.0 to 109 °C (autoranging)
	PC.C	PTC	-50.0 to 150 °C (autoranging)
	nC.F	NTC	-58.0 to 228 °F (autoranging)
	PC.F	PTC	-58.0 to 302 °F (autoranging)
	P1.C	Pt 1000	-50.0 to 850 °C (autoranging)
	P1.F	Pt 1000	-58.0 to 999 °F (autoranging)

[11] dP = Decimal point

Range: YES = Autoranging display;
no = display without decimal point.

[12] CA = Offset on the displayed value

Range: -300 to 300 engineering units.

[13] Ft = Filter on the displayed value

Range: from 0 (OFF) to 20 seconds.

[14] o1F = Out 1 function

Range: H.rE = PID control with heating action (reverse);
C.rE = PID control with cooling action (direct);
on.H = ON/OFF control with heating action (reverse);
on.C = ON/OFF control with cooling action (direct).

[15] tr1 = Out 1 cycle time

Range: from 1 to 250 seconds.

[16] o2F = Out 2 function

Range:

- When o1F is equal to H.rE or C.rE:
no = Not used
HAL = Absolute high alarm;
LAL = Absolute low alarm;
b.AL = Band alarm (symmetric to the set point);
dHA = Deviation high alarm;
dLA = Deviation low alarm.
- When o1F = on.H or on.C:
no = Not used;
HAL = Absolute high alarm;
LAL = Absolute low alarm;
b.AL = Band alarm (symmetric to the set point);
dHA = Deviation high alarm;
dLA = Deviation low alarm;
SP.C = SP2 - ON/OFF control with cooling action;
SP.H = SP2 - ON/OFF control with heating action;
nr = ON/OFF Neutral Zone (o2F will make the opposite action to the one programmed on o1F, while the hysteresis [par. d1] becomes the neutral zone).

Note: The Neutral Zone functioning is used to control the plants with an element that causes a positive increase (ex. Heating, Humidifying etc.) and an element that causes a negative increase (ex. Cooling, Dehumidifying etc.).

The control works on the programmed outputs depending on the measure, on the active Set point "SP", and on the programmed hysteresis "d1".

The regulator works in the following way: it switches off the outputs when the process value reaches the Set and activates the heating output when the process value is lower than [SP-d1], or it switches on the cooling output when the process value is higher than [SP+d1].

Accordingly, the element that causes positive increase must be connected to the output programmed as heating, while the element of negative increase must be connected to output programmed as cooling.

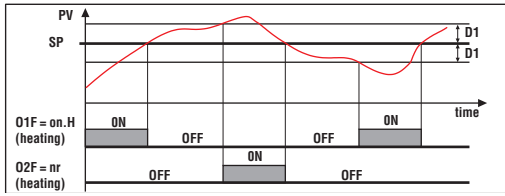

Table of the possible combinations

O1F	O2F	Displayed parameters
H.rE	H.AL, L.AL, b.AL, dHA, dLA	SP1, AL
C.rE	H.AL, L.AL, b.AL, dHA, dLA	SP1, AL
on.H	H.AL, L.AL, b.AL, dHA, dLA	SP1, AL
	SP.C, SP.H	SP1, SP2
	Nr	Sp1 only
on.C	H.AL, L.AL, b.AL, dHA, dLA	SP1, AL
	SP.C, SP.H	SP1, SP2
	Nr	SP1 only

[17] d1 = Out 1 hysteresis or neutral zone

Available: when Out 1 is equal to hn.H or on.C.

Range: 0.1 to 999 engineering units.

[18] d2 = Out 2 hysteresis

Available: when o2F is different from nr.

Range: 0.1 to 999 engineering units.

[19] AL.F = Alarm function

Available: when o2F is programmed as alarm output.

Range: AL = Automatic reset Alarm;
AL.n = Latched Alarm;
AL.A = Acknowledgeable Alarm.

AL = Automatic reset Alarm

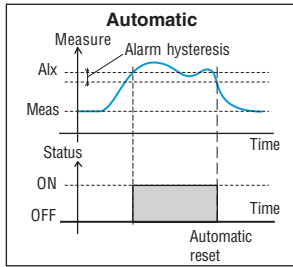

AL.n = Latched Alarm

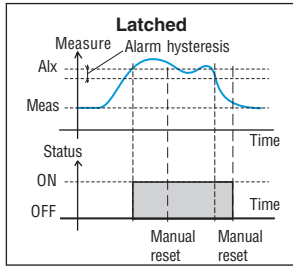

AL.A = Acknowledgeable alarm

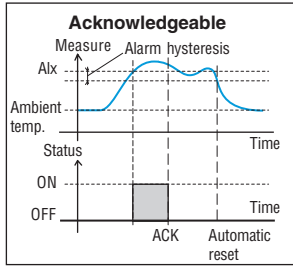

[20] AL.t = Inhibition time of the alarm at the start up or after a change of set point

Range: from 0 = OFF (any hiding) to 9.59 HH.mms

Note: When the measure reaches the alarm threshold, the instrument disables the hiding of the alarm.

[21] Pct = Compressor protection time

The protection prevents the output cycling and therefore reduces relay wear by waiting for the time setting to elapse before allowing a subsequent switching of the output. In other words, it defines the minimum time that will pass between the switch off of a cooling output and its following reactivation.

Available: if at least one output is programmed as cooling output.

Range: from 0=OFF to 9.59 HH.mm

Note: This parameter has effect to ALL the cooling outputs.

[22] SSt = Soft start time

Range: 0=OFF to 9.59 HH.mm.

Note: When the control is ON/OFF type, the time of the soft start becomes an output time delay, the power is forced to 0 and the parameter SSP is hidden.

[23] SSP = Power during Soft Start

Available: when Sst is different from 0.

Range: 0 to 100%.

Note: if programmed = 0, also the alarms and/or the second control output remains = 0 and the instrument visualizes "od" for the programmed time.

[24] ub.F = U key function

Range: no = No function
Tun = It activates the manual tuning;
Sb = Stand-by mode;
Sb.o = Stand-By mode with display off.

[25] PP = Parameters protection Password

Range: 1 to 999.

[26] Lo = Time for the Key lock automatic enable

This parameter allows to set the time that the instrument will wait before to automatically enable the key lock. The time count will re-start after a key pressure.

Range: from OFF (lock disabled) to 30 minutes.

5. ERROR MESSAGES

5.1 - OUT OF RANGE SIGNALS

The display shows the OVER-RANGE and UNDER-RANGE conditions with the following indications:



The sensor break will be signaled as follows:



Note: When an over-range or an under-range is detected, the alarms operate as in presence of the maximum or the minimum measurable value respectively.

To check the out of span Error condition, proceed as follows:

- 1) Check the input signal source and the connecting line;
- 2) Make sure that the input signal is in accordance with the instrument configuration. Otherwise, modify the input configuration (see section 4).
- 3) If no error is detected, send the instrument to your supplier to be checked.

5.2 - LIST OF POSSIBLE ERRORS

AtE - Auto-tune not finished within 12 hours.

EPr - Possible problem of the instrument memory.

The messages disappears automatically.

When the error continues, send the instrument to your supplier.

6. GENERAL NOTES

6.1 - PROPER USE

Every possible use not described in this manual must be considered as a improper use.

This instrument is in compliance with EN 61010-1 "Safety requirements for electrical equipment for measurement, control and laboratory use"; for this reason it must not be used as a safety equipment.

Whenever a failure or a malfunction of the control device may cause dangerous situations for persons, thing or animals, please remember that the plant has to be equipped with additional safety devices.

Ascon Tecnologic S.r.l. and its legal representatives do not assume any responsibility for any damage to people, things or animals deriving from violation, wrong or improper use or in any case not in compliance with the instrument's features.

6.2 - WARRANTY AND REPAIRS

We warrant that the products will be free from defects in material and workmanship for 18 months from the date of delivery. Products and components that are subject to wear due to conditions of use, service life, and misuse are not covered by this warranty.

The warranty is limited to repairs or to the replacement of the instrument.

The tampering of the instrument or an improper use of the product will bring about the immediate withdrawal of the warranty's effects.

In the event of a faulty instrument, either within the period of warranty or further to its expiry, please contact our sales department to obtain authorisation for sending the instrument to our company.

The faulty product must be shipped to Ascon Tecnologic with a detailed description of the faults found, without any fees or charge for Ascon Tecnologic, except in the event of alternative agreements.

Before supplying tension to the instrument, make sure that it is perfectly dry.

7. PARAMETERS TABLE

no.	Par.	Description	Range	Default	Protection
1	SPL	Minimum Set Point value	From -99.9 to SPH E.U.	-99	Yes
2	SPH	Maximum Set Point value	From SPL to 999 E.U.	999	Yes
3	SP1	Set point	From SPL to SPH E.U.	0	No
4	SP2	Second Set Point	From SPL to SPH E.U.	0	Yes
5	AL	Alarm threshold	From -99.9 to 999 E.U.	0	Yes
6	tun	Autotuning	ALL = Performed at every start up onE = Performed at the first start up ub = Performed when U key is pressed	onE	Yes
7	Pb	Proportional Band	From 1 to 999 E.U.	50	Yes
8	ti	Integral time	From 1 to 500 seconds and OFF	100	Yes
9	td	Derivative time	From 0 (OFF) to 200 seconds	25	Yes
10	SEn	Input type F type A type T type	JC = TC J (°C) CA.C = TC K (°C) JF = TC J (°F) CA.F = TC K (°F) Pt.C = PT 100 (°C) Pt.F = PT 100 (°F) nC.C = NTC (°C) PC.C = PTC (°C) nC.F = NTC (°F) PC.F = PTC (°F) P1C = PT 1000 (°C) P1F = PT 1000 (°F)	J.C Pt.C nC.C	Yes
11	DP	Decimal point	YES = Autoranging visualization no = Visualization without decimal point	no	Yes
12	CA	Offset on the displayed value	From -300 to 300 E.U.	0	Yes
13	Ft	Filter on the displayed value	From 0 (OFF) to 20 seconds	0	Yes
14	O1F	Out 1 function	H.rE = PID control with heating action C.rE = PID control with cooling action on.H = ON/OFF control with heating action on.C = ON/OFF control with cooling action	HrE	Yes
15	tr1	Out 1 cycle time	From 1 to 250 seconds	30	Yes

no.	Par.	Description	Range	Default	Protection
16	o2F	Out 2 function When o1F = H.rE or C.rE When o1F = on.H or on.C	no = Not used HAL = Absolute high alarm LAL = Absolute low alarm b.AL = Band alarm (symmetric to the set point) dHA = Deviation high alarm dLA = Deviation low alarm no = Not used HAL = Absolute high alarm LAL = Absolute low alarm b.AL = Band alarm (symmetric to the set point) dHA = Deviation high alarm dLA = Deviation low alarm SP.C = SP2 ON/OFFcontrol with cooling action SP.H = SP2 ON/OFF control with heating action nr = ON/OFF neutral zone	No	Yes
17	d1	Out 1 hysteresis or neutral zone	From 0.1 to 999 E.U.	1	Yes
18	d2	Out 2 hysteresis	From 0.1 to 999 E.U.	1	Yes
19	ALF	Alarm function	AL = Automatic reset Alarm AL.n = Latched Alarm AL.A = Acknowledgeable Alarm	AL	Yes
20	ALt	Inhibition time of the alarm at the start up or after a change of set point	From 0 (OFF) to 9.59 HH.mm	0	Yes
21	Pct	Compressor protection time	From 0 (OFF) to 9.59 HH.mm	0	Yes
22	Sst	Soft start time	From 0 (OFF) to 9.59 HH.mm	0	Yes
23	SSP	Power during Soft Start	From 0 to 100%	0	Yes
24	UbF	U key function	no = No function Tun = It activates the manual tuning Sb = Stand-by mode Sb.o = Stand-By mode with display off	tun	Yes
25	PP	Parameters protection Password	From 1 to 999	0	Yes
26	Lo	Key lock time out	From 0 (key lock disabled) to 30 minutes	0	Yes