



AC SERVO DRIVES SIGMA-5 SERIES



EN

DE

ES

FR

IT

Σ -V SERIES
 Σ -V SERIES
 Σ -V SERIES

Σ-V SERIES

About YASKAWA

Contents

- ▶ **Page 2**
About YASKAWA
Experience & Innovation
- ▶ **Page 3**
Sigma-5 – New Servo-Drives
Series
- ▶ **Page 4 – 5**
Advanced Performance
Outstanding Expandability
- ▶ **Page 6 – 7**
Simple Start-up
- ▶ **Page 8 – 9**
Standard Motors
- ▶ **Page 10 – 12**
Direct drives
- ▶ **Page 13**
Specifications
- ▶ **Page 14 – 15**
Dimensions

Experience & Innovation

For more than 90 years YASKAWA has been supplying mechatronic products and is one of the leading companies for motion control products worldwide. YASKAWA develops and manufactures Inverter Drives, Servo Drives and Motion Controllers and has introduced many

ground-breaking innovations over the past decades. YASKAWA products are used in all fields of machine building and industrial automation and have a high reputation for their outstanding quality and durability.

Sigma-5 – New Servo-Drive Series from YASKAWA: highest accuracy, easiest set-up and unlimited connectivity

Sigma-5 is a servo pack, consisting of servo motors, servo amplifiers and a powerful set-up tool. Sigma-5 replaces the successful Sigma-2 series which has been available for several years now for a wide range of applications. Customers using the Sigma-2 products for their machines, will have sufficient time to implement the changeover to Sigma-5.

The new Sigma-5 series offers rotary, direct drive and linear motors. The rotary servo motor range will be available in several performance categories between 0.1 and 15 kW. They cover all market demands with regard to compact size, high dynamics, high efficiency, low maintenance and outstanding reliability.

The most impressive feature of the Sigma-5 series is its positioning accuracy of up to 10 nm with standard products, while offering shortest positioning times. In addition, the well known autotuning function

YASKAWA Sigma-5 Features

Highest performance for maximum efficiency

- ▶ optimised servo motors
- ▶ high resolution serial encoders
- ▶ servo amplifiers with ASICs (Application Specific Integrated Circuit)
- ▶ new intelligent algorithms
- ▶ precise and fast positioning
- ▶ vibrationless motion
- ▶ smooth running at lowest speed
- ▶ highest quality
- ▶ no manual adjustment required

User-friendly software for fast and easy set-up

- ▶ set-up software "SigmaWin+"
- ▶ no expert know-how is necessary to achieve optimum setting results
- ▶ optimized autotuning function
- ▶ automatic filter function to suppress vibrations



YASKAWA Servos

was optimised for the most sophisticated applications. Example: The new autotuning algorithm allows for the perfect set-up of a servo axis in a high dynamic performance machine in less than two hours – compared to more than eight hours needed by other solutions currently available in the market.

In short, Sigma-5 offers precise positioning at highest speed, smooth, vibration-free operation and easiest start up. For machine builders this means:

- ▶ Shortest cycle time – highest throughput
- ▶ Better product quality
- ▶ Less machine wear
- ▶ Shortest initial set-up time
- ▶ lowest lifecycle cost

Suitable for many applications

The major benefits of Sigma-5, such as precise and fast positioning, highest machine speed, vibrationless motion, smooth running at lowest speed, make Sigma-5 ideal for machines in the fields of electronics, semi-conductors, packaging, printing and machine tools. The new Sigma-5 generation will also be a perfect match for the injection molding and metal forming industries, where high throughput and point-to-point positioning are decisive factors.

A Passion for Quality

Since the company was founded, YASKAWA has been aiming at total quality. And while continuous improvement of the manufacturing process certainly is an important aspect of quality, the concept of total quality comprises more: The quest for quality needs to be an integral part of the construction process. Quality cannot be added on afterwards by adopting special production processes. Every day, more than 6 million servo drives worldwide are running and a proof of the high quality and reliability of YASKAWA products.

- ▶ automatic adjustment of the servo amplifiers to a wide range of inertia ratios
- ▶ free download of the servo motor selection program "SigmaSize+"

Versatile communication with machine controllers

- ▶ embedded open fieldbus system MECHATROLINK-II
- ▶ via several open and ethernet based fieldbus systems

Compact and efficient:

new design with many benefits

- ▶ re-designed servo motors
- ▶ number of parts was reduced by about 30%
- ▶ increased vibration resistance by 100% to 5G
- ▶ powerlosses down by 30%
- ▶ advanced winding technologies
- ▶ high performance magnets

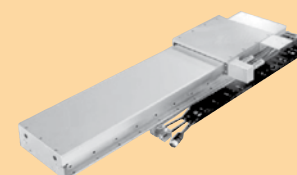
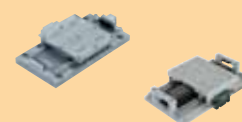
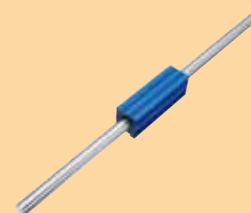

Σ-V SERIES

Superlative Performance

Operate your machinery faster and with higher precision than ever!

The Sigma-5 delivers the highest performance in the industry.

The best amplifier response in the industry slashes settling time

▶ In-house comparison: 1/12th



Outstanding frequency response
1,6 kHz

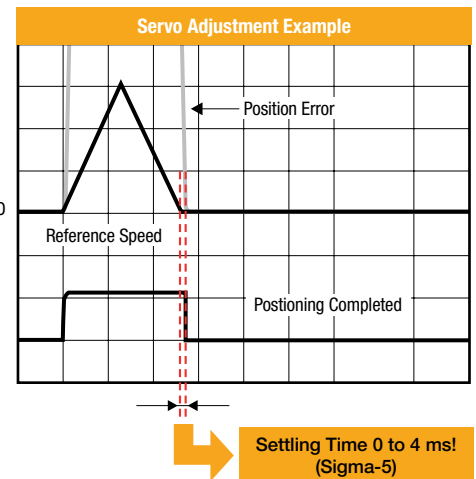

Enhanced vibration suppression

Existing functions to minimize vibration have been enhanced, and new ones added, improving tracking and further improving settling time. Vibration and noise during driving have also been cut, along with vibration at machine edges when stopping.

Contributing to machine performance in conjunction with a medium-inertia motor

Small Capacity

▶ SGMJV Series



Low Heating

▶ Improved motor constants have reduced both losses and heating.

Better Tact Time

▶ Peak torque has been boosted from 300% to 350%, contributing to shorter tact times

Ease of Use

▶ Moment of inertia has been doubled in the same motor, reducing the load inertia ratio and boosting gain for faster settling

Medium Capacity

▶ SGMGV Series

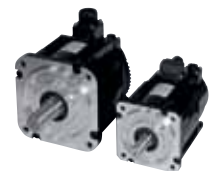

Compact Design

▶ Smaller package and about 20% lighter, but with the same inertia as the conventional model. A small encoder connector is applied.

Improved Vibration Resistance

▶ New coupling delivers typical 5G vibration resistance

ENCODER RESOLUTION
1,048,576 PULSES/REVOLUTION

Σ -V SERIES



Outstanding Expandability

Use servos that really fit into your system

A rich selection of models and options to match your requirements

- ▶ **Extensive variety of motors to match any machine**
 Medium-inertia servo motors ▶ Improved control stability
 Low-inertia servo motors ▶ High-speed acceleration and deceleration
- ▶ **Selection of servo actuators**
 Support for direct drive servo motors, linear servo motors and linear sliders
- ▶ **Standard support for analog voltage/pulse train reference series or MECHATROLINK-communications reference series**



Option Module

THE FIRST IN THE INDUSTRY IN JAPAN!
(AS OF APRIL 2007)

- ▶ **Wide selection of option modules for various communication interfaces and feedback**
- ▶ **Compliant with applicable safety standards**
 Easy compliance with machine safety standards
- ▶ **Motor line-up to handle a wide range of markets and applications**

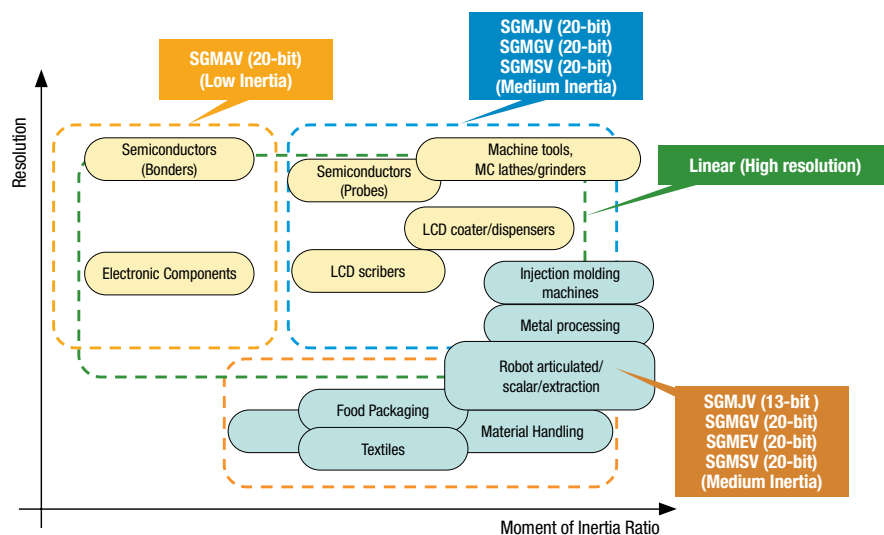

Faster setup

Simple Start-up

Making servo adjustment

Let the Sigma-5 series simplify your life!

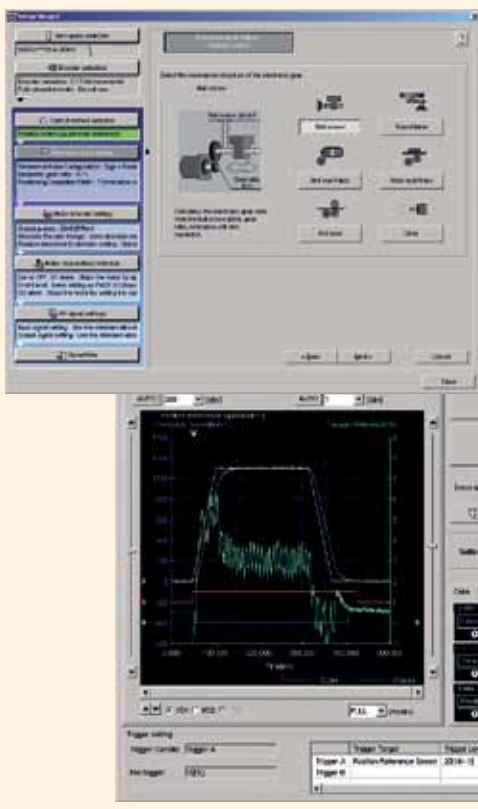

Setup Wizard

- ▶ Simple parameter set-up with wizard-aided input

SigmaWin+

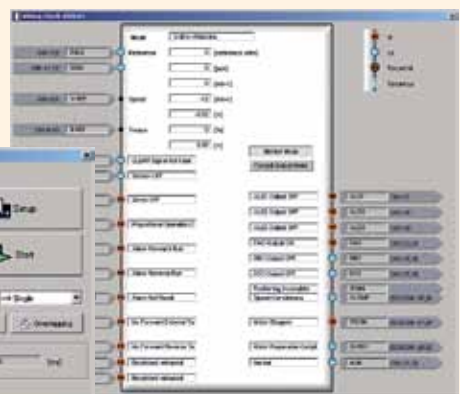

Wiring Check Function

- ▶ The SigmaWin+ wiring check function checks your wiring in a single operation

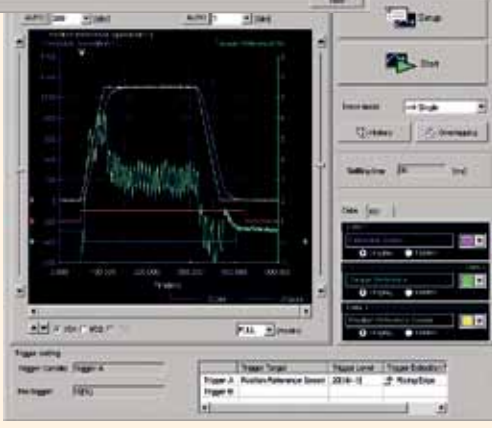

Trace Function

- ▶ Realtime trace of adjustment state means you can check instantly.

USB 1.1 SUPPORT

Full of handy functions for start-up and more effective operation!

Servo motor capacity selection software
SigmaJunmaSize+

Selection

- ▶ Optimal selection for your application:
With consideration of moment of inertia, DB resistance, etc.



Free download at the YASKAWA Software Download Portal: <http://www.yaskawa.eu.com/index.php?id=899>

Simple Tuning

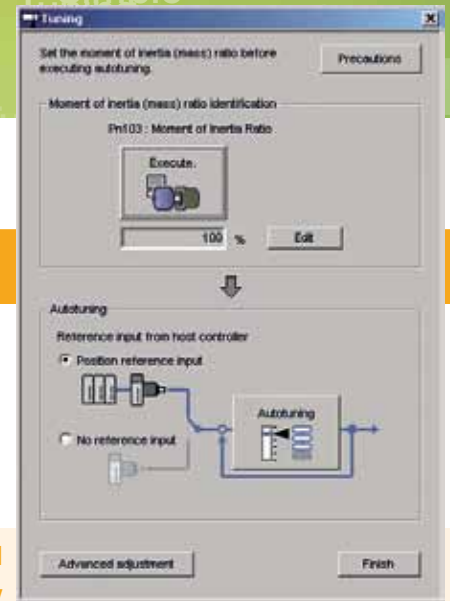

New Advanced Autotuning Window

Gain and Filter Adjustment

Operation

New Tuning-less Function

- ▶ Get up and running quickly after hooking up the motor

Even without servo adjustment and with load changes, oscillation- and vibration-free drive is possible up to 20 times the load moment of inertia.

Settling time: 100 to 150 ms level

New Advanced Autotuning

- ▶ Minimize settling time with less vibration

The reference filter and feedback gain adjustment functions have a new automatic feed forward gain adjustment for optimal adjustment performance. The friction compensation function automatically cancels out the effect of friction on machine characteristics.

Settling time: 10 ms level

New "One-parameter" Tuning

- ▶ Fine-tuning is a must

Fine-tuning can tweak machine performance to the max.

Settling time: 0 to 4 ms level

Maintenance

PC tool

SigmaWin+

Faster Troubleshooting



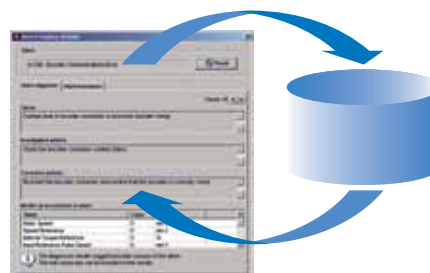

- ▶ Alarm diagnostic function: Presumes possible causes of the alarm and immediately displays suggested corrective actions.



Free download at the YASKAWA Software Download Portal: <http://www.yaskawa.eu.com/index.php?id=899>

Standard Motors

Rotary Servomotors

Rotary Servomotor Model		Capacity	Rated Torque [Nm]	Instantaneous Peak Torque [Nm]	Rated Speed [min ⁻¹]	Max. Speed [min ⁻¹]	SERVOPACK Model SGD _V - □□□□	
							Three-phase 200 VAC	Three-phase 400 VAC
SGMJV (Medium Inertia, Small Capacity) 6000 min ⁻¹ 	SGMJV-A5A	50 W	0.159	0.557	3000	6000	R70A	-
	SGMJV-01A	100 W	0.318	1.11			R90A	
	SGMJV-02A	200 W	0.637	2.23			1R6A	
	SGMJV-04A	400 W	1.27	4.46			2R8A	
	SGMJV-08A	750 W	2.39	8.36			5R5A	
SGMAV (Low Inertia, Small Capacity) 6000 min ⁻¹ 	SGMAV-A5A	50 W	0.159	0.477	3000	6000	R70A	-
	SGMAV-01A	100 W	0.318	0.955			R90A	
	SGMAV-C2A	150 W	0.477	1.43			1R6A	
	SGMAV-02A	200 W	0.637	1.91			2R8A	
	SGMAV-04A	400 W	1.27	3.82			5R5A	
	SGMAV-06A	550 W	1.75	5.25			120A*1	
	SGMAV-08A	750 W	2.39	7.16				
	SGMAV-10A	1 kW	3.18	9.55				
SGMEV (Low and Medium Inertia, Small Capacity, optional IP67) 5000 min ⁻¹  	SGMEV-01A	100 W	0.318	0.955	3000	5000	R90A	-
	SGMEV-02A	200 W	0.637	1.91			1R6A	
	SGMEV-04A	400 W	1.27	3.82			2R8A	
	SGMEV-08A	750 W	2.39	7.16			5R5A	
	SGMEV-15A	1500 W	4.77	14.3			120A*1	
	SGMEV-02D	200 W	0.637	0.191			-	1R9D
	SGMEV-03D*2	300 W	0.955	3.82				1R9D
	SGMEV-04D	400 W	1.27	3.82				1R9D
	SGMEV-07D*2	650 W	2.07	7.16				3R5D
	SGMEV-08D	750 W	2.39	7.16				3R5D
	SGMEV-15D	1500 W	4.77	14.3				5R4D

*1: Single-phase 200 VAC SERVOPACKs are also available (base-mounted SERVOPACK model: SGD_V-120A □□A008000, rack-mounted SERVOPACK model: SGD_V-120A □□A009000).

*2: Different motor length for SGMEV-03D and SGMEV-07D.



Standard Motors

Rotary Servomotor Model		Capacity	Rated Torque [Nm]	Instantaneous Peak Torque [Nm]	Rated Speed [min ⁻¹]	Max. Speed [min ⁻¹]	SERVOPACK Model SGD□-□□□□		
							Three-phase 200 VAC	Three-phase 400 VAC	
SGMGV (Medium Inertia, Medium Capacity) 3000 min ⁻¹		SGMGV-03D	300 W	1.96	5.88	1500	3000	-	1R9D
		SGMGV-05D	450 W	2.86	8.92				3R5D
		SGMGV-09D	850 W	5.39	13.8				5R4D
		SGMGV-13D	1.3 kW	8.34	23.3				8R4D
		SGMGV-20D	1.8 kW	11.5	28.7				120D
		SGMGV-30D	2.9 kW	18.6	45.1				170D
		SGMGV-44D	4.4 kW	28.4	71.1				210D
		SGMGV-55D	5.5 kW	35.0	87.6				260D
		SGMGV-75D	7.5 kW	48.0	119				280D
		SGMGV-1AD	11 kW	70.0	175				370D
		SGMGV-1ED	15 kW	95.4	224				
SGMSV (Low Inertia, Medium Capacity) 6000 min ⁻¹		SGMSV-10D	1.0 kW	3.18	9.54	3000	5000	-	3R5D
		SGMSV-15D	1.5 kW	4.9	14.7				5R4D
		SGMSV-20D	2.0 kW	6.36	19.1				8R4D
		SGMSV-25D	2.5 kW	7.96	23.9				120D
		SGMSV-30D	3.0 kW	9.8	29.4				
		SGMSV-40D	4.0 kW	12.6	37.8				
		SGMSV-50D	5.0 kW	15.8	47.6				

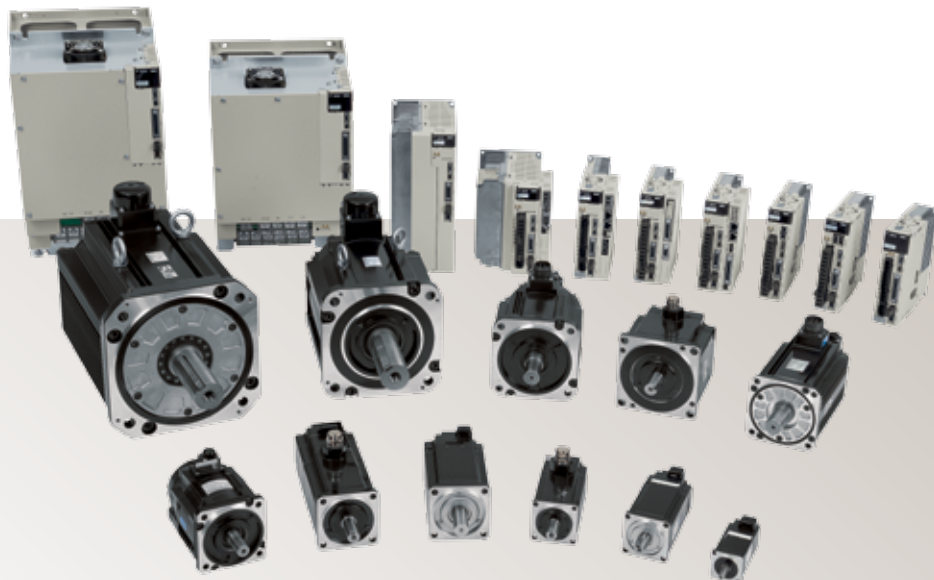

Direct Drives

Linear Servomotors

Linear Servomotor Model		Rated Force [N]	Peak Force [N]	Peak Speed [m/s]	SERVOPACK Model SGD _V - □□□□		
					Three-phase 200 VAC	Three-phase 400 VAC	
SGLGW (Coreless Type, With standard-force magnetic ways) 	SGLGW-30A050C	12.5	40	5.0	R70A	-	
	SGLGW-30A080C	25	80		R90A		
	SGLGW-40A140C	47	140		1R6A		
	SGLGW-40A253C	93	280	4.8	2R8A		
	SGLGW-60A140C	70	220		5R5A		
	SGLGW-40A365C	140	420		120A		
	SGLGW-60A253C	140	440	4.0	180A		
	SGLGW-60A365C	210	660		200A		
	SGLGW-90A200C	325	1300				
	SGLGW-90A370C	550	2200				
SGLGW-90A535C	750	3000					
SGLGW (Coreless Type, With high-force magnetic ways) 	SGLGW-40A140C	57	230	4.2	1R6A	-	
	SGLGW-60A140C	85	360		2R8A		
	SGLGW-40A253C	114	460		3R8A		
	SGLGW-40A365C	171	690		7R6A		
	SGLGW-60A253C	170	720				
	SGLGW-60A365C	255	1080				
SGLFW (With F-type Iron Core) 	SGLFW-20A090A	25	86	5.0	1R6A	-	
	SGLFW-20A120A	40	125		3R8A		
	SGLFW-35A120A	80	220		5R5A		
	SGLFW-35A230A	160	440		120A		
	SGLFW-50A200B	280	600		4.9		200A
	SGLFW-50A380B	560	1200				
	SGLFW-1ZA200B	560	1200	4.5	-	1R9D	
	SGLFW-1ZA380B	1120	2400			3R5D	
	SGLFW-35D120A	80	220	5.0		5R4D	
	SGLFW-35D230A	160	440				
	SGLFW-50D200B	280	600				
	SGLFW-50D380B	560	1200				
	SGLFW-1ZD200B	560	1200	2,3	120D		
	SGLFW-1ZD380B	1120	2400				
	SGLFW-1ED380B	1500	3600				
	SGLFW-1ED560B	2250	5400				



Direct Drives



Linear Servomotor Model		Rated Force [N]	Peak Force [N]	Peak Speed [m/s]	SERVOPACK Model SGD _V -□□□□		
					Three-phase 200 VAC	Three-phase 400 VAC	
SGLTW (With T-type Iron Core) 	SGLTW-20A170A	130	380	5.0	3R8A		
	SGLTW-35A170A	220	660		5R5A		
	SGLTW-35A170H	300	600	4.8			
	SGLTW-50A170H	450	900	3.2			
	SGLTW-20A320A	250	760	5.0	7R6A		
	SGLTW-20A460A	380	1140				
	SGLTW-35A320A	440	1320	4.8	120A		
	SGLTW-35A320H	600	1200				
	SGLTW-50A320H	900	1800	3.1			
	SGLTW-35A460A	670	2000	5.0	180A		
	SGLTW-40A400B	670	2600	3.1			
	SGLTW-40A600B	1000	4000				
	SGLTW-80A400B	1300	5000	2.5	330A		
	SGLTW-80A600B	2000	7500				
	SGLTW-35D170H	300	600	5.0	-		3R5D
	SGLTW-50D170H	450	900	4.0			
	SGLTW-35D320H	600	1200	5.0			
	SGLTW-50D320H	900	1800	4.0			
	SGLTW-40D400B	670	2600	3.1			120D
	SGLTW-40D600B	1000	4000				
SGLTW-80D400B	1300	5000					
SGLTW-80D600B	2000	7500					

Cylinder Type Servomotors (Sigma-Stick)

Linear Servomotor Model		Rated Force [N]	Peak Force [N]	Peak Speed [m/s]	SERVOPACK Model SGD _V -□□□□
					Three-phase 200 VAC
SGLC 	SGLC-D16A085A	17	60	4.0	-
	SGLC-D16A115A	25	90		
	SGLC-D16A145A	34	120		
	SGLC-D20A100A	30	150		
	SGLC-D20A135A	45	225		
	SGLC-D20A170A	60	300		
	SGLC-D25A125A	70	280		
	SGLC-D25A170A	105	420		
	SGLC-D32A165A	90	420		
	SGLC-D25A215A	140	560		
	SGLC-D32A225A	135	630		
	SGLC-D32A285A	180	840		

Direct Drives

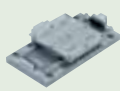
Linear Slider (Sigma-Trac)

Linear Slider Model		Rated Force [N]	Peak Force [N]	SERVOPACK Model SGD V-□□□□	
				Three-phase 200 VAC	
 SGTMM (Sigma-Trac-μ)	SGTMM01	3.5	10	R70A	
	SGTMM03	7	25	R90A	
 SGTMF (Sigma-Trac-MAG)	SGTMF4A	90	270	1R6A	
	SGTMF4B	120	360		
	SGTMF5A	150	540	5R5A	
	SGTMF5B	200	720		



Linear Slider (SGT)

Linear Slider Model		Rated Force [N]	Peak Force [N]	SERVOPACK Model SGD V-□□□□	
				Single-phase 200 VAC	Three-phase 400 VAC
Type	Model*1				
 SGT-□ - Linear Slider	SGT-F35A120 □	80	220	SGDV-1R6A □5A	-
	SGT-F35A230 □	160	440	SGDV-3R8A □5A	
	SGT-F50A200 □	280	600	SGDV-5A5A □5A	
	SGT-F50A380 □	560	1200	SGDV-5A5A □5A	
	SGT-F1ZA200 □			SGDV-120A □5A*2	
	SGT-F35D120 □	80	220	-	
	SGT-F35D230 □	160	440		SGDV-1R9D □5A
	SGT-F50D200 □	280	600		SGDV-3R5D □5A
	SGT-F50D380 □	560	1200		SGDV-5R4D □5A
	SGT-F1ZD200 □				SGDV-5R4D □5A
	SGT-F1ZD380 □	1120	2400		SGDV-120D □5A

*1 Manufactured by YASKAWA Engineering Europe GmbH.

*2 Single-phase 200 VAC, 1.5 kW, SGD V-120A □ 1A008000

Direct Drive Servomotors

Direct Drive Servomotor Model		Rated Torque [Nm]	Peak Torque [Nm]	Rated Speed [min ⁻¹]	Max. Speed [min ⁻¹]	SERVOPACK Model SGD V-□□□□
						Three-phase 200 VAC
 SGMCS (Small-capacity)	SGMCS-02B	5	6	200	500	2R8A
	SGMCS-05B	7	15			
	SGMCS-07B	4	21			
	SGMCS-04C	10	12			
	SGMCS-10C	14	30			
	SGMCS-14C	8	42			
	SGMCS-08D	17	24	150	250	5R5A
	SGMCS-17D	25	51			
	SGMCS-25D	16	75			
	SGMCS-16E	35	48			
SGMCS-35E	45	105	150	250		
 SGMCS (Medium-capacity)	SGMCS-45M	80	135	150	300	7R6A
	SGMCS-80M	80	240			120A
	SGMCS-80N	110	240			180A
	SGMCS-1AM	150	330			
	SGMCS-1EN	200	450			
	SGMCS-2ZN	15.8	600			200A



Specifications

SERVOPACK specifications

Position		Specifications
Performance		Speed frequency response: 1.6 kHz (load condition: Load moment of inertia J_L = Motor moment of inertia J_M) Torque control tolerance (repeatability): +/- 1%
Analog Voltage/ Pulse Train Reference Type	Position Control	Reference pulse type: Sign + pulse train, 90° phase difference 2-phase pulse (phase A + phase B), or CCW + CW pulse train Form: Non-insulated line driver (+5 V level), open collector
	Speed Control	+/- 6 VDC (variable setting range: +/- 2 to 10 VDC) at rated speed, max. input voltage: +/- 12 V)
	Torque Control	+/- 3 VDC (variable setting range: +/- 1 to 10 VDC) at rated torque, max. input voltage: +/- 12 V)
	Built-in Panel Operator	Status display, parameter settings, adjustment functions*1, utility functions*2 by using the 7-segment 5-digit LED (red) and push switch (4 channels)
MECHATROLINK-II Communications Reference Type	Performance	Position control, speed control, and torque control through MECHATROLINK communications
	Command Input	MECHATROLINK commands and MECHATROLINK-II commands (for sequence, motion, data setting/reference, monitor, adjustment, and other commands)
	Display and Switch	7-segment 1-digit LED (red), one rotary switch (for station address setting), and four dip switches (for communications specifications setting)
Communications	Type	RS-422A communications: Hand-held digital operator, RS-422A port of personal computers, etc. USB communications: Compliant with USB1.1 standard, personal computers can be connected with SigmaWin+
	Functions	Status display, parameter settings, adjustment functions*1, utility functions*2
Feedback		Serial encoder: 20-bit (incremental/absolute encoder). Serial encoder: 13-bit (incremental encoder only for SGMJV servomotors)
Input Signals	Number of Channels	7 channels. The signal allocation and positive/negative logic can be modified.
	Functions	Servo On, proportional control, alarm reset, forward run prohibited, reverse run prohibited, forward torque limit, reverse torque limit, internal set speed selection, control selection, zero clamping, reference pulse inhibit, gain selection, homing deceleration switch signal, external latch signal
Output Signals	Number of Channels	3 channels. The signal allocation and positive/negative logic can be modified.
	Functions	Positioning completion, speed coincidence detection, servomotor rotation detection, servo ready, torque limit detection, speed limit detection, brake, warning, near
Encoder Output Pulses		Phase A, phase B, phase C: line driver output. The number of dividing pulse: Any setting ratio is available.
Other I/O Signals		Alarm output, alarm code output (3-bit, open collector output)
Analog Monitor		Analog monitor connector built in for monitoring speed, torque and other reference signals. Number of points: 2
Protective Functions		Overcurrent, overvoltage, low voltage, overload, regeneration error, etc.
Option Card Functions		Advanced safety functions (Stop category 1, 2, Safely-limited speed), serial encoder communications input for fully-closed loop control, various fieldbus interfaces
Compliant Standards		UL standards, CE marking (EMC directive, low voltage directive), harmonics suppression, RoHS, safety function
Safety Functions		EN 954 category 3 Stop category 0, IEC 61508 SIL 2 Input: Power module base block signal. Output: Safety circuit status monitor
Configuration		Base-mounted (Rack mounting and duct mounting available as an option for some models.)
Option	Network	EtherCAT, CANopen, Powerlink, PROFINET
	Motion Control	Indexer, MP2600iec

*1: New tuning-less function, advanced autotuning or one-parameter tuning, etc.

*2: Alarm traceback data display, JOG operation, origin search, etc.

Dimensions

Dimensional drawings (units: mm)
- Rotary servomotor

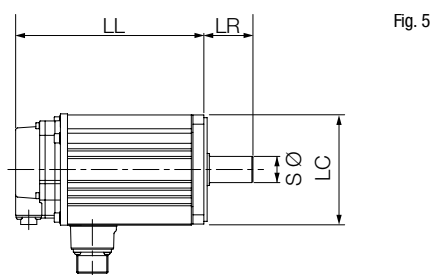
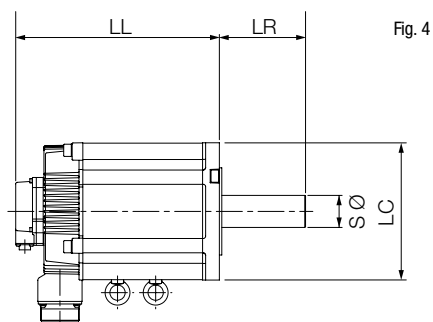
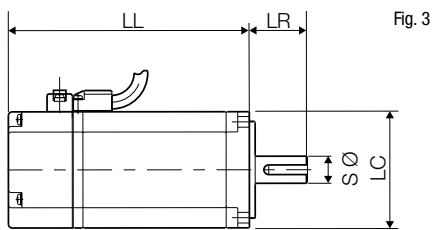
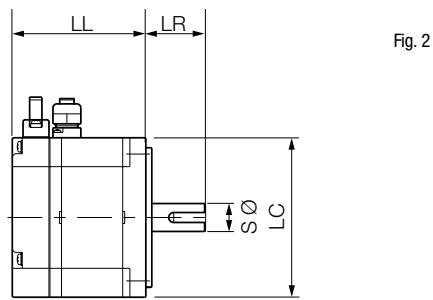
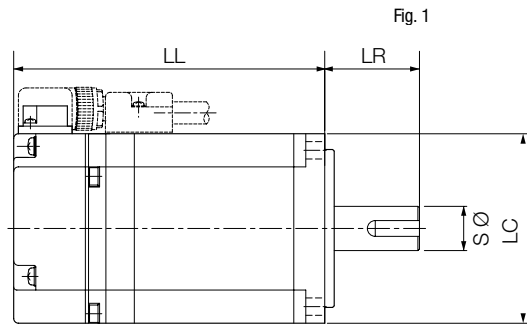

Input Voltage	Servomotor Model	Capacity	Figure	□ LC	LL	LR	S Dia.	Approx. Mass kg
200 VAC	SGMJV-A5	50 W	1	40	69	25	8	0.3
	SGMJV-01	100 W			82.5			0.4
	SGMJV-02	200 W		60	80	30	14	0.9
	SGMJV-04	400 W			98.5			1.3
	SGMJV-08	750 W			80			115
200 VAC	SGMAV-A5	50 W	1	40	70.5	25	8	0.3
	SGMAV-01	100 W			82.5			0.4
	SGMAV-C2	150 W		60	94.5	30	14	0.5
	SGMAV-02	200 W			80			0.9
	SGMAV-04	400 W			98.5			1.2
	SGMAV-06	550 W		80	124.5	40	19	1.7
	SGMAV-08	750 W			115			2.6
	SGMAV-10	1.0 kW			145			3.6
200 VAC	SGMEV-01	100 W	2	60	62	25	8	0.7
200 VAC, 400 VAC	SGMEV-02	200 W		80	67	30	14	1.4
	SGMEV-04	400 W			87			2.1
	SGMEV-08	750 W		120	86.5	40	16	4.2
SGMEV-15	1.5 kW	114.5	19		6.6			
400 VAC	SGMEV-03	300 W	3	60	124.5	30	14	1.7
	SGMEV-07	650 W		80	145	40	16	3.4
400 VAC	SGMGV-03	300 W	4	90	126	37	14	2.6
	SGMGV-05	450 W			139	40	16	3.2
	SGMGV-09	850 W			137	19	5.5	
	SGMGV-13	1.3 kW		130	153	58	22	7.1
	SGMGV-20	1.8 kW			171	24	8.6	
	SGMGV-30	2.9 kW			160	79	35	13.5
	SGMGV-44	4.4 kW		180	184	113	42	17.5
	SGMGV-55	5.5 kW			221			21.5
	SGMGV-75	7.5 kW			267			29.5
SGMGV-1A	11 kW	220	331	116	55	57		
SGMGV-1E	15 kW		393			67		
400 VAC	SGMSV-10	1.0 kW	5	100	147	45	24	4.1
	SGMSV-15	1.5 kW			157			4.6
	SGMSV-20	2.0 kW			173			5.4
	SGMSV-25	2.5 kW		130	196	63	28	6.8
	SGMSV-30	3.0 kW			233			10.5
	SGMSV-40	4.0 kW			273			13.5
	SGMSV-50	5.0 kW						16.5

Note: External dimensions of direct-drive servomotors, linear servomotors, and linear sliders are shown in specific YASKAWA Europe product publications.



Dimensions

- SERVOPACK
- SERVOPACK with Option Module
Command Option Attachable Type

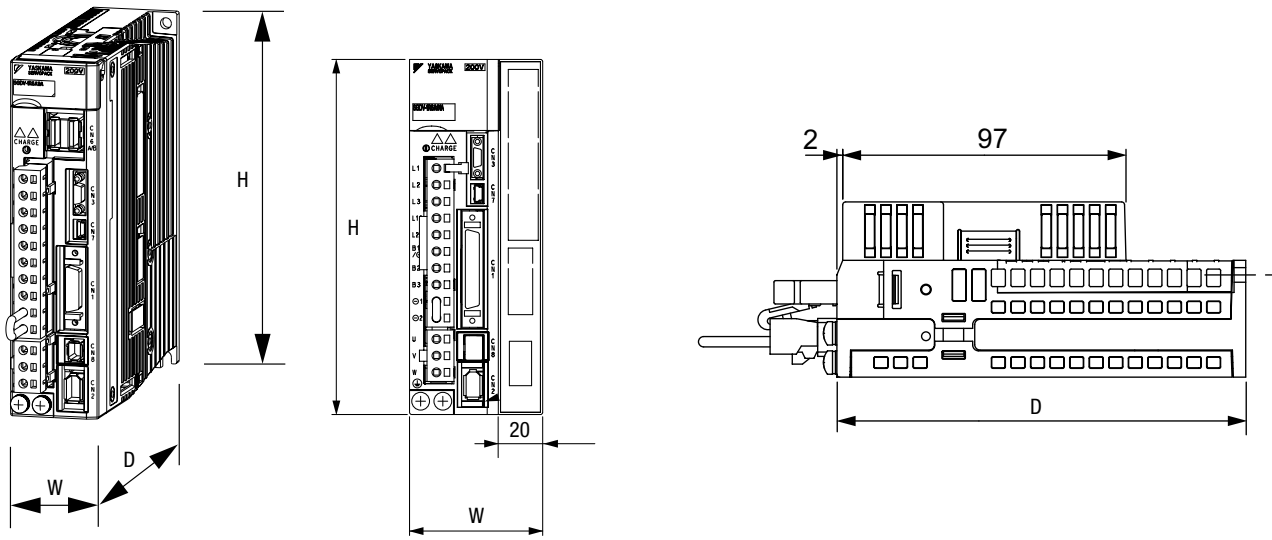

Input Voltage	SERVOPACK Model SGDV-	W	H	D	Approx. Mass kg	SERVOPACK Command Option Attachable Type			
						W	H	D	Approx. Mass kg
Three-phase 200 VAC	R70A R90A 1R6A	40	160	140	0.9	60	160	140	1.0
	2R8A					170		1.1	
	3R8A 5R5A 7R6A	70	160	170	1.5	90	160	180	1.6
	120A	90				2.4			110
	180A 200A	100	180	180	2.8	120	180	210	2.9
	330A	110	250	4.6	130	250	4.7		
	470A 550A	170	350	210	10.2	190	350	10.3	
	590A 780A	260	450			21	280	450	275
Three-phase 400 VAC	1R9D 3R5D 5R4D	110	160	275	2.7	130	160	180	2.8
	8R4D 120D								
	170D	135	5.6	155	230	5.7			
	210D 260D	230	350	230	11.3	250	350	210	11.4
	280D 370D		400	210	16.2	250	400	250	16.3



YASKAWA Europe GmbH

Drives & Motion Division
Hauptstr. 185
65760 Eschborn
Germany

+49 6196 569-300
info@yaskawa.eu.com
www.yaskawa.eu.com

The Sigma-5 Series is CE-certified,
cULus-listed and RoHS-conform.

